









Part	Picture	Qty.
A		5
B		1
C		1
D		1
E		1
F	 M8x20	3
G	 5mm	1
H		2
I		2
J		1

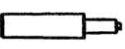

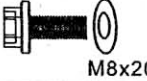
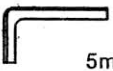
Headrest adjustment:

To adjust the headrest height, lift up the headrest (1) to desired position.

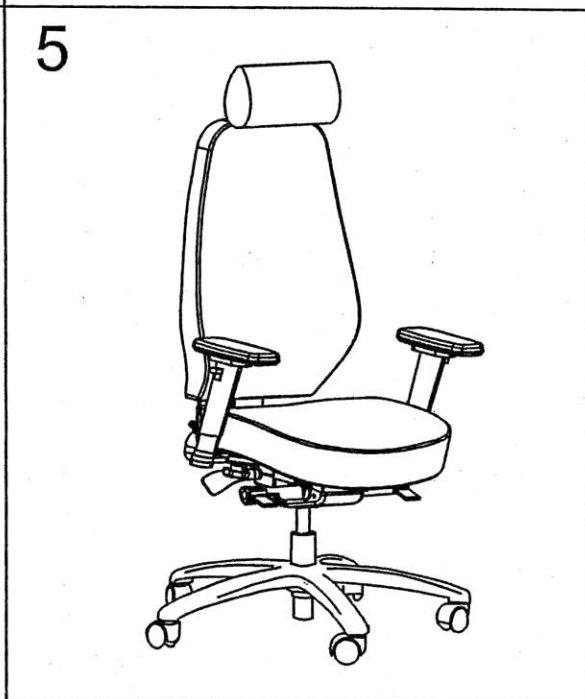
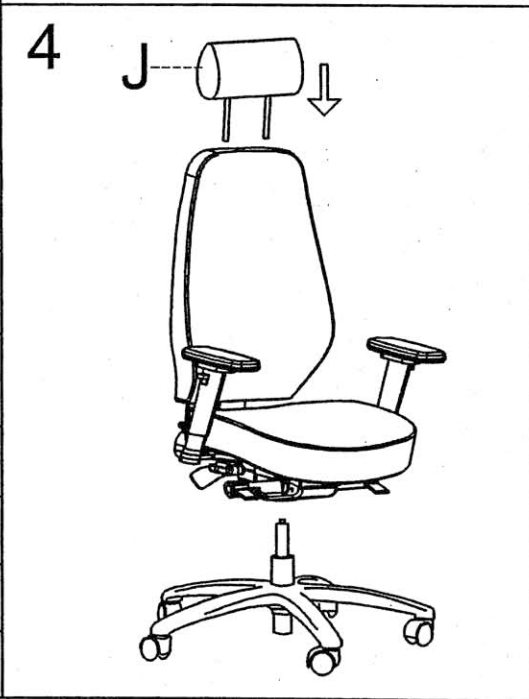
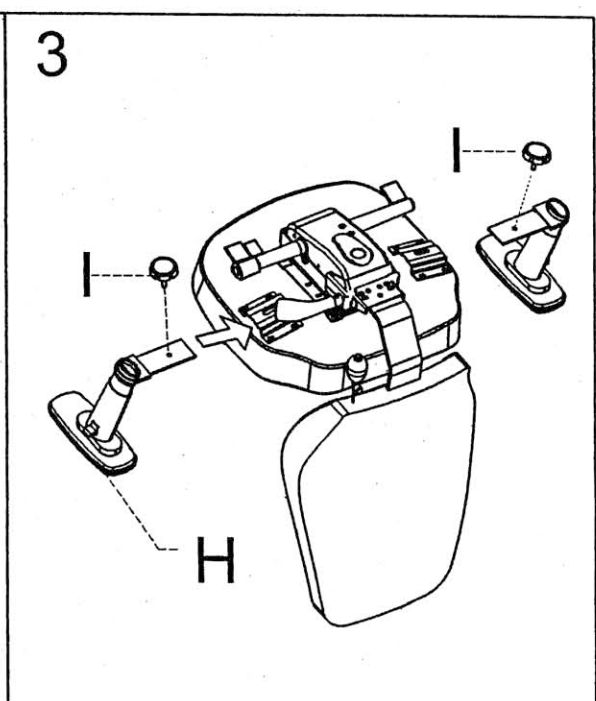
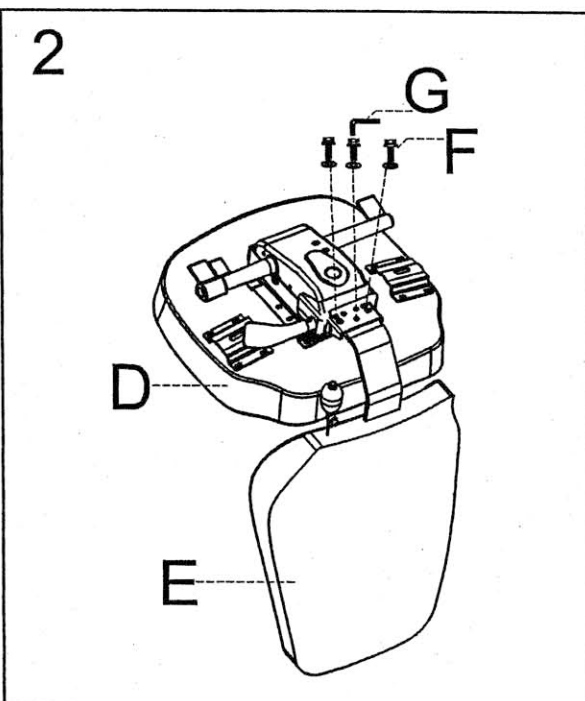
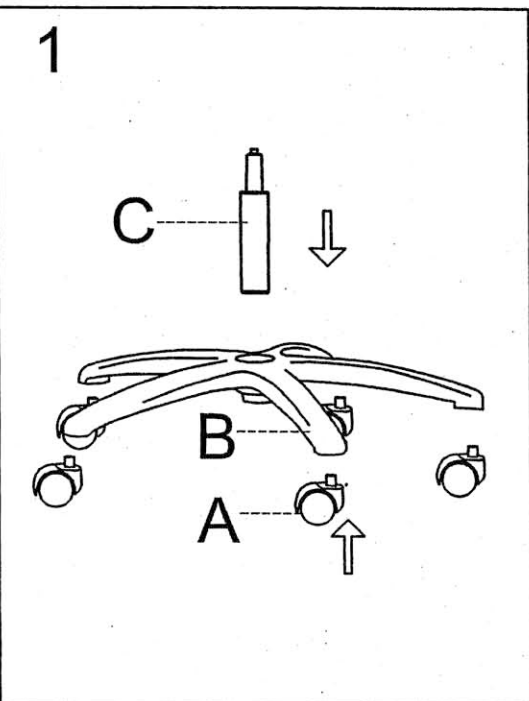
To adjust the headrest angle, turn the headrest directly to desired angle.

Back height adjustment:

To change the back height (2), lift up the back by putting your force at the bottom of the back, then adjust the back height step by step.

Only the back reach the highest position, then can pull down the back to the first position (lowest position).

Armrest adjustment (3):

To rise up or lower down the armrest, pull up the button on the armrest and move up or down.

To move the arm top position, push the top forward or pull backward.

To move the arm top left and right position, turn the top to left side or right side.

To adjust the arm width, turn anticlockwise the knob to unlock the arm, pull or push the arm to desired position, then turn clockwise the knob to lock.

Seat angle adjustment (Forward Tilt):

To adjust the seat angle, turn the seat angle adjustment handle (4) backward to unlock and lift up the seat end up or down, then turn frontward the handle to lock at the desired position.

Tilt tension adjustment:

To adjust the seat tilt tension, pull out and turn the tension adjustment lever (5)

on the mechanism to desired tension, turn clockwise or anticlockwise. Clockwise to stronger, anticlockwise to weaker.

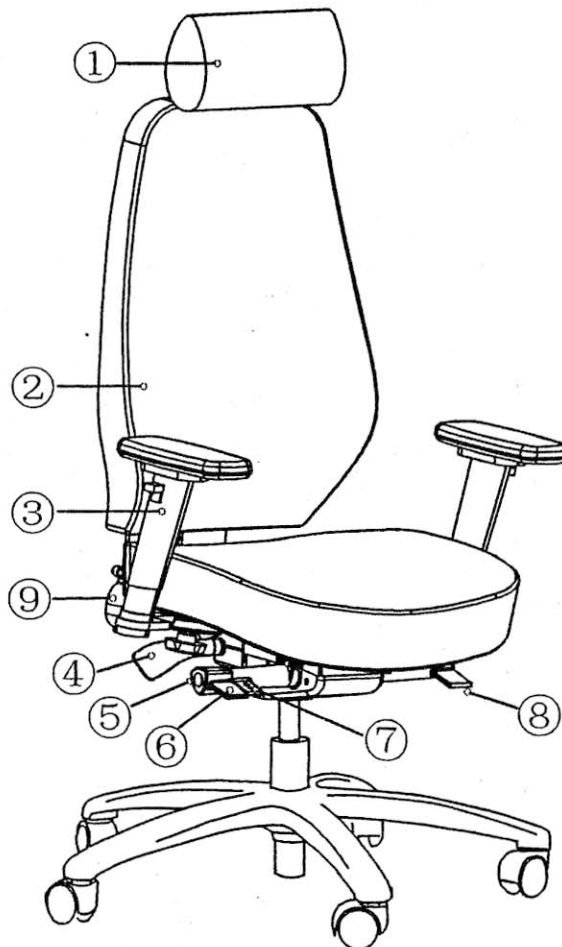

Seat height adjustment:

To raise the seat height, remove weight from the seat and pull up on the height adjustment lever (6), release the lever when reaching the desired position.

To lower the seat height, while seated, pull up slowly on the height adjustment lever until the seat is at the desired height.

Seat depth adjustment:

To enlarge the seat depth, push down the slider lever (7) and move forward to desired position, then release the lever.

To go back to the first position, push down the slider lever and remove body weight from the seat.

Backrest angle adjustment (Tilt Lock):

To change backrest's position, pull up the adjustment lever

(8), then lie backwards the backrest to desired position, and push down the adjustment lever to lock.

To go back to the first position, pull up the adjustment lever, lie backwards again and then backrest will return automatically.

Lumbar support adjustment:

To enlarge the lumbar support (air bag) depth, hold and press the pump (9) until it reach your desired position.

To reduce the depth, press the button (10) on the pump to release the air until it reach your desired position.

